

# **Dell External USB Slim DVD +/-RW Optical Drive-DW316**

**User's Guide**





NOTE: A NOTE indicates important information that helps you make better use of your computer.



**CAUTION:** A CAUTION indicates potential damage to hardware or loss of data if instructions are not followed.



**WARNING:** A WARNING indicates a potential for property damage, personal injury, or death.

© 2014 Dell Inc. All rights reserved.

Information in this document is subject to change without notice. Reproduction of these materials in any manner whatsoever without the written permission of Dell Inc. is strictly forbidden **Trademarks used in this text:** Dell and the Dell logo are trademarks of Dell Inc., Intel®, Centrino®, Core™, and Atom™ are either trademarks or registered trademarks of Intel Corporation in the U.S. and other countries; Microsoft®, Windows®, and Windows start button logo are either trademarks or registered trademarks of Microsoft Corporation in the United States and/or other countries; Bluetooth® is a registered trademark owned by Bluetooth SIG, Inc. and is used by Dell under license; Blu-ray Disc™ is a trademark owned by the Blu-ray Disc Association (BDA) and licensed for use on discs and players; Other trademarks and trade names may be used in this document to refer to either the entities claiming the marks and names or their products. Dell Inc. disclaims any proprietary interest in trademarks and trade names other than its own.

# Contents:

---

## Contents

- a. Dell External USB Slim DVD +/-RW Optical Drive-DW316
- b. USB cable (600 mm)
- c. CyberLink Media Suite Software CD



# Index

---

[Introduction](#)

[Using the Drive](#)

[Connectivity](#)

[Troubleshooting](#)

[Specifications](#)

[Regulatory](#)

---

**Information in this document is subject to change without notice.**

# Introduction:

---

## Drive Description

This drive reads and writes to CD and DVD media (Refer to Specification section for specific media types). This drive has a slim form factor.

## Special Features Of the Drive

- USB 2.0 Interface (480 Mbits/s).
  - Drawer load type, portable slim USB DVD +/-RW Drive.
  - CD-R/RW, DVD-R/RW/RAM/+R/+RW/+R DL/-R DL, M-DISC (DVD+R SL) read and write compatible.
  - CD Family and DVD-ROM read compatible.
  - Large buffer memory 0.75 MB.
  - Active OPC (Running OPC) "Optimum Power Controller" provides for more reliable writes.
  - Supports UDF (Universal Disk Format) for easy writing to CD/DVD recordable and rewritable discs.
  - Improved Buffer Under Run Error handling through the Preventive function.
1. Continuously monitors the signal level during recording and adjusts the laser power to compensate and ensure a flat signal.
  2. Supports both 12 cm and 8 cm standard round-type disc.
  3. PC USB powered, no AC adaptor needed.
  4. Eject button to eject the disc when the optical drive is being connected and powered by computer.
  5. Emergency Eject hole to manually eject the disc in case of a drive failure or a power outage.

## Using the Drive:

---

### Front Panel

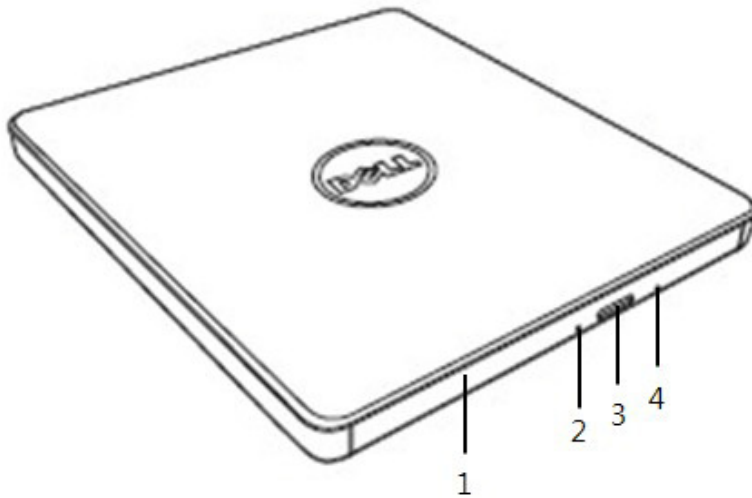

- 1. Disc Tray**  
The disc tray opens automatically when you press the eject button. When you place a disc in the tray, ensure that the label on the disc is facing outwards. If you are not loading or unloading a disc, the tray should remain closed.
- 2. Indicator Light**  
The light blinks when there is drive activity.
- 3. Eject Button**  
Press this button to open the disc tray. This button works only when power is supplied to the drive.
- 4. Emergency Eject Hole**  
If the disc tray does not open when you press the eject button, power off the computer, insert a pin or unfolded paper clip in the hole and push firmly. Refer to Emergency Eject instructions below.

## Rear Panel



### 1. USB port

Connect to the computer's USB port.

## Drive Operation:

### Inserting a Disc

- Press the eject button. The disc tray will be ejected.
- Place the disc in the center of the tray with the label side facing up.
- Push disc onto hub until secure.
- Push the disc tray by hand and completely close.

### Removing a Disc

- Press the eject button. The disc tray will be ejected.
- Remove the disc.
- Push the disc tray till it closes completely.

 **NOTE:** During some drive activities, the drive will not allow the tray to open even when the eject button is pressed.

### Usage Guidelines

- Do not press down on the disc tray when it is in opening or closing operation.
- Do not place objects on the disc tray.
- Never use a damaged, broken, scratched, or deformed disc.
- Keep the disc tray closed when the drive is not in use.

 **NOTE:** High-speed drives spin the disc at a high rotational speed. If a disc has printing on only half of the disc, or if there is a slight imbalance in the disc, the imbalance is greatly magnified by the high speed, causing the drive to vibrate or produce a fan-like noise. These effects are inherent in the high-speed technology and do not indicate a problem with the drive.

## Emergency Eject

The procedure described below can be used to remove a disc from the drive if the eject button is disabled by software or if a power failure occurs.

1. Turn the computer off.
2. Insert a small diameter rod or a stiff wire (a straightened paper clip about 1.2 mm [0.047 in] in diameter) into the emergency eject hole and push firmly.
3. The disc tray is ejected by about 10 mm (0.39 in). Pull the disc tray out.

 **NOTE:** Do not insert more than 50 mm (1.9 in) in depth.  
Inserting more than 50 mm (1.9 in) may damage the drive.

## Cleaning Media

- If dust or fingerprints get on the disc, wipe it with a soft cloth from the center to the edge.

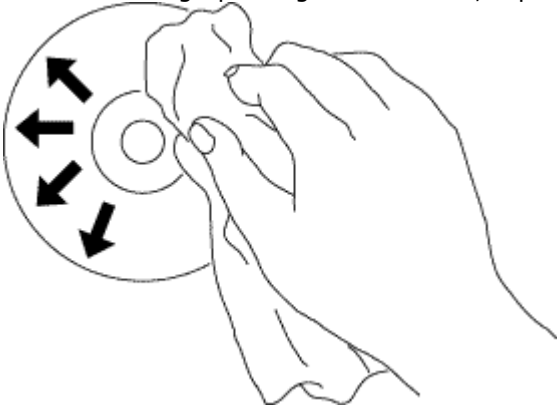

 **CAUTION:** Do not use benzene, paint thinner, record cleaner, solvent or static repellent. This can damage the disc.



## Safety Instructions

- *Do not move the drive suddenly from a cold place to warm one. Condensation may cause abnormal operation.*
- *Make sure to remove the disc before moving the drive to prevent the possible damage to the disc.*
- *Does not use the Emergency Eject feature except in case of a power outage.*
- *Prevent foreign objects, such as liquids or metal, from entering the drive and in the case a foreign object enters the drive, please consult the dealer where the drive was purchased.*
- *Do not interrupt the electric power while the drive is operating.*
- *Do not attempt to open the cover. To reduce the risk of electric shock, do not remove the cover. There are no user-serviceable parts inside. Refer servicing to qualified service personnel.*
- *While drive is operating, do not move the drive or give a shock to the drive, since it can cause damages to the disc.*
- *Please pay attention to handling Electrostatic Sensitive Devices; you may use anti-static products such as wrist, heel straps, and mats to protect your body from electrostatic.*
- *Please do not connect the extension cable by any means other than specified.*
- *The drive is not intended for use by young children or infirm persons without supervision. Young children should be supervised to ensure that they do not play with drive.*

## Cleaning the Drive

Cleaning the inside of the drive is not recommended.

# Connectivity:

---

## Installation

These instructions apply to most commonly used computers.

### Before connection

- Make sure you have a computer with any open USB port before connecting the drive to your computer.
- Connecting the drive with the wrong interface port can cause it to malfunction. Follow the instructions when connecting the drive.



### Connecting to computer

1. Connect the USB cable to a USB connector on your computer. This drive does not have power switch.  
The drive turns on when connected to your computer.
2. When the computer is ready, confirm that the drive is detected. And then, insert the burn and playback application installation disc into the External USB DVDRW drive and install the software

## Usage of the extended cable

---

### Disconnection

The disconnection procedure varies depending on your OS.

The drive supports the plug and play (not swap) function of Windows, and can be removed and inserted by performing the following operation.

1. Stop the application software that is using the optical disk drive.
2. Click the icon  of the task bar located on your screen's bottom right side.
3. Operate following the message displayed, if any.
4. Remove the USB cable.

 **NOTE:** Do not remove USB cable when the busy indicator on the drive blinks, or during computer start up.

# Troubleshooting:

## Symptoms and Solutions

Symptoms	Solutions
1. Drive is not recognized by system.	<p>1-1. Drive cable may be connected improperly. Verify the interface cable is connected properly. Disconnect and reconnect the drive.</p> <p>1-2. Portable USB drive may not be configured properly. The drive gets its power from the USB interface. The use of non-powered hubs and/or daisy-chaining USB peripherals can keep the drive from getting enough power to function. Try plugging the drive directly into the USB port on the computer.</p>
2. Cannot read or play disc.	<p>2-1. If the disc is dirty (fingerprints, etc.), clean it with a non-abrasive cloth from the disc center hole to the outside.</p> <p>2-2. If the disc is scratched and warped, do not insert it into the drive.</p> <p>2-3. If the disc is inserted upside-down, reinsert it in the proper direction.</p> <p>2-4. If the drive is not recognized, refer to section 1 above.</p> <p>2-5. Check to see that the necessary software applications are installed correctly.</p>
3. Certain types of discs do not play.	<p>3-1. This drive only supports discs with the formats indicated in the Specifications section. It cannot read the data on discs with other formats. Check the disc's format.</p>
4. Drive activity indicator does not light up.	<p>4-1. Drive cable may be connected improperly. Verify the interface cable is connected properly. Disconnect and reconnect the drive.</p> <p>4-2. Portable USB drive may not be configured properly. The drive gets its power from the USB interface. The use of non-powered hubs and/or daisy-chaining USB peripherals can keep the drive from getting enough power to function.</p> <p>4-3. Try plugging the drive directly into the USB port on the computer.</p>
5. Drive will not write or read at maximum speed.	<p>5-1. Make sure disc is clean and free of scratches.</p> <p>5-2. Media from different manufacturers or purchased at different times will record at different speeds. The drive will adjust the available recording speeds to achieve the highest write quality.</p>
6. Cannot insert disc.	<p>6-1. Check to see that the system is powered up. (The indicator LED light will blink on pressing the eject button on the drive.)</p> <p>6-2. Please press eject button to check if a media is inside the drive.</p> <p>6-3. Turn off the drive (or PC) and then turn it on again. It will reset and allow the drive to return back to normal condition.</p>

<p>7. Cannot eject disc.</p>	<p>7-1. Check to see that the system is powered up. (The indicator LED light will blink on pressing the eject button on the drive.)</p> <p>7-2. If a media is stuck in the drive, please turn off the drive (or PC) then turn on it again. Under normal condition, it will reset and allows normal operation of the drive to resume.</p> <p>7-3. Use Emergency Eject instructions to eject a disc. Please refer to the Using the Drive section.</p> <p>7-4. If the system is capable of booting into an operating system, attempt to issue an eject command from within the operating system</p>
<p>8. Cannot write to disc (for drives with write capability).</p>	<p>8-1. Is the disc loaded in the drive with the read/write surface facing the right direction? The label should be facing up. If a disc does not have a label, the disc code on the inner side of the disc should be properly oriented for reading when looking from the top of the disc.</p> <p>8-2. CD-R, DVD-R and DVD+R discs cannot be re-written.</p> <p>8-3. Please check the type of disc that is being used. Please refer to Specifications section to ensure that the disc type is supported by this drive.</p> <p>8-4. Is there enough free space on the writable disc?</p> <p>8-5. Did a screen saver or other applications operate while writing to the disc? If so, try again with the application turned off.</p>

## Specifications:



*NOTE: These specifications are provided by the manufacturer for information purposes only and do not constitute an extension of Dell's warranty to you. Dell's warranty is contained in the documentation that came with your system.*

## Supported Functions

Media Type	Write <sup>1</sup>	Read
CD-ROM	N/A	OK
CD-R	OK	OK
High Speed CD-RW	OK	OK
Ultra Speed CD-RW	OK	OK
Ultra Speed Plus CD-RW	NO	OK
120 mm (CD)	OK	OK
80 mm (CD)	OK	OK
Business Card (CD)	OK	OK
Stamped DVD – 5, 9, 10, 18	OK	OK
DVD-R (Authoring)	NO	OK
DVD-R (SL & DL)	OK	OK
DVD+R (SL & DL)	OK	OK
M-Disc (DVD+R SL)	OK	OK
DVD-RW	OK	OK
DVD+RW	OK	OK
DVD-Download	NO	OK
DVD-RAMV 2.1	OK	OK
120 mm (DVD)	OK	OK
80 mm (DVD)	OK	OK
Business Card (DVD)	OK	OK
Mount Rainier formatted DVD+RW media	NO	NO
BD-ROM (SL & DL)	N/A	NO
BD-R (SL & DL)	NO	NO
BD-RE (SL & DL)	NO	NO
120 mm (BD)	N/A	NO
80 mm (BD)	N/A	NO
OK = supported NO = not supported N/A for not applicable		
Format	Write	Read
CD-DA	N/A	OK
CD-ROM	N/A	OK
CD-ROM XA	N/A	OK
Video CD	N/A	OK
CD-I <sup>2</sup>	N/A	OK

<b>Photo CD</b> <sup>2</sup>	N/A	OK
<b>CD-Extra</b>	N/A	OK
<b>Super Video CD</b>	N/A	OK
<b>Super Audio CD Hybrid Disc</b>	N/A	OK
<b>Mount Rainier formatted CD-RW media</b>	NO	NO
<b>DVD-Video</b>	N/A	OK
<b>DVD-Audio</b>	N/A	OK
<b>DVD-Data (Single Session)</b>	OK	OK
<b>DVD-Data (Multi Session/border)</b>	OK	OK
<b>Mount Rainier formatted CD-RW media</b>	NO	NO
<b>BD-MV</b>	NO	NO
<b>BD-AV</b>	NO	NO
<b>BD-Data</b>	NO	NO
<b>AVCREC</b>	NO	NO
OK = supported NO = not supported N/A for not applicable		
<b>Copy protection / Data security</b>	<b>Write</b>	<b>Read</b>
<b>Support CPRM</b> <sup>3</sup>	OK	OK
<b>Support VCPS</b> <sup>3</sup>	N/A	NO
OK = supported NO = not supported N/A for not applicable		

<sup>1</sup> Write requires appropriate application software.

<sup>2</sup> CD-I and PhotoCD may require special reader/player software. PhotoCD writing requires Kodak license.

<sup>3</sup> For CPRM and VCPS support, appropriate application software is required.

## Extended Specifications

<b>System Interface</b>	Data transfer speed	External(Host): USB 2.0 (480Mbit/s) Internal(Drive): T13 ATA/ATAPI-8, MMC-6, INF-8090i v8
<b>Performance</b>		
<b>CD</b>		Key: insert "Max X" speed for each media below. For CD 1 x=150 KB/s; DVD 1 x=1350 KB/s; BD 1 x = 4.5 MB/s
	Read	24 x max. CAV
	Digital Audio Extraction (DAE)	24 x max. CAV
	Write CD-R	10x CLV, 16 x ZCLV, 24 x CAV
	Write CD-RW	Multi Speed: 4 x CLV High Speed: 10 x CLV Ultra Speed: 24 x ZCLV

<b>DVD</b>		
	Read DVD-ROM (Single Layer / Dual or Double Layer)	8 x max. CAV
	Read DVD+R/+RW/+R Double Layer	8 x max. CAV
	Read M-Disc (DVD+R SL)	8 x max. CAV
	Read DVD-RAM	6 x max. CAV
	Write DVD+/-R	8 x max. CAV
	Write DVD+/-R Double Layer	6 x max. PCAV
	Write M-Disc (DVD+R SL)	4 x max. PCAV
	Write DVD-RAM	5 x max. PCAV
	Write DVD+RW	8 x max. ZCLV
	Write DVD-RW	6 x max. ZCLV
<b>Power Consumption</b>	Typical	Stand-by (Sleep) 113 mA Continuous Read 700 mA Continuous Write 800 mA Seek 800 mA
<b>Acoustic noise</b>	Operating (Sound pressure level, typical)	Less than 50 dBA at 0.25 m away from bezel and 0.45 m heights away.
<b>Power supply</b>	Voltage	+5 V +/- 5 % ripple less than 100 mVp-p
<b>Temperature</b>	Operating C (F)	5 ° to 40 ° C (41 ° to 104 ° F)
	Non-operating C (F)	-30 ° to 60 ° C (-22 ° to 140 ° F)
<b>Relative Humidity</b>	Operating (No condensation)	15 % to 85 %
	Non-operating (No condensation, Power Off, without disc)	10 % to 90 %
<b>Altitude</b>	Operating m (ft)	0 m ~ 3,000 m
	MTBF:	150,000 power on hours (POH)
<b>Dimensions and weight</b>		
	Width	144 mm
	Depth	137.5 mm
	Height	14 mm
	Weight	About 200 g



## **Regulatory:**

---

### **Regulatory Information**

Dell External USB DVDRW Drive - DW316 (GP61NB60) complies with the FCC/CE rules and abides by worldwide regulatory compliance, engineering, and environmental affairs.

### **Contacting Dell:**

1. Visit [www.dell.com/support](http://www.dell.com/support)
2. Select your support category
3. Select the appropriate service or support link based on your need.